

NICEVIEW

Muunneltava asennusvarsi NWDisplay- tuotteille







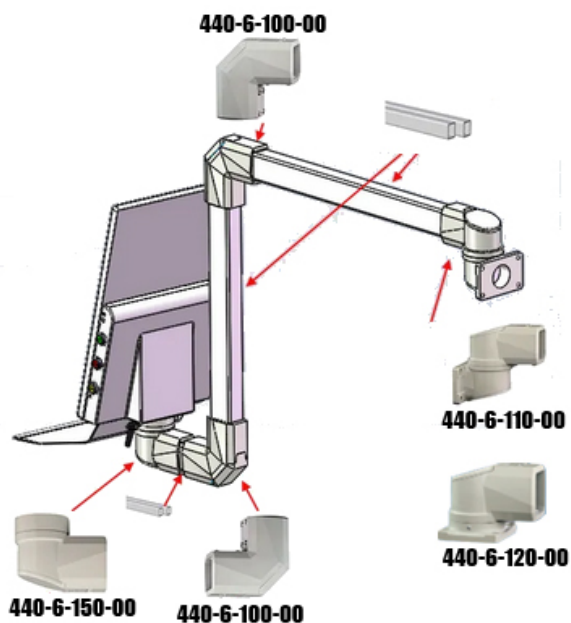
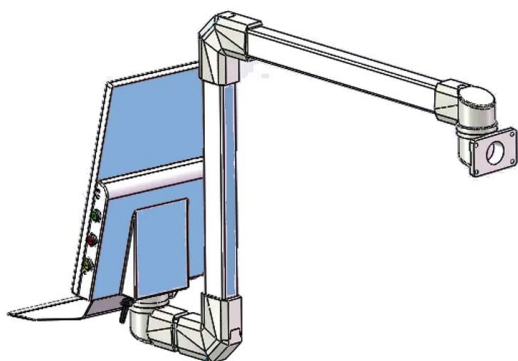

Muunneltavalla asennusvarrella voidaan näyttöyksikkö sijoittaa haluttuun paikkaan.

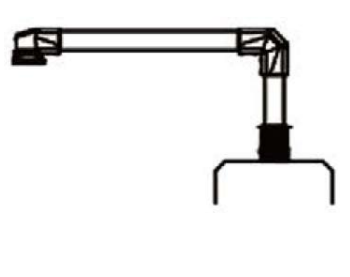
Varsi on moduulirakenteinen, jolloin se on hyvin muokattavissa eri käyttötarkoituksiin ja kohteisiin.

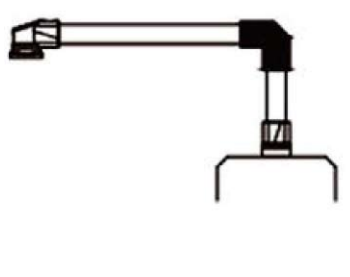
- Base -osat kiinnitetään työstökoneen tms. runkoon.
- Putkiosat voidaan katkaista haluttuun pituuteen.
- Box Connector -osat kiinnitetään NWDisplay näyttöön.
- Kaapelit voidaan viedä varren sisällä.
- Soveltuu erityisen hyvin NWLink4:n kanssa käytettäväksi, jolloin tarvitaan vain virtajohto sekä CAT6A -kaapeli.

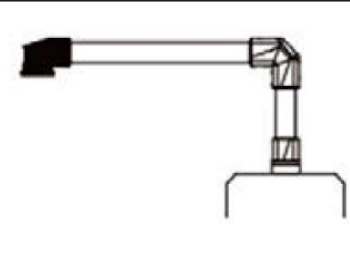

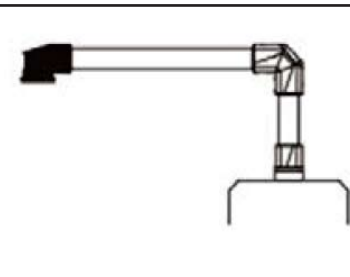

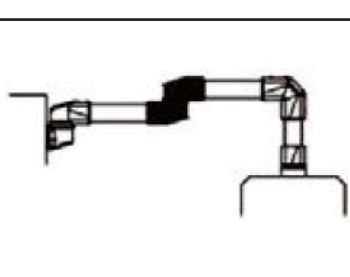
NICEVIEW

MFR #	Description		
440-6-090-00	Box Connector		
440-6-100-00	90deg Connector		
440-6-110-00	Horizontal Wall Base		
440-6-120-00	Top Base		
440-6-130-00	Pipe Connector		

NICEVIEW

MFR #	Description		
440-6-140-00	Base		
440-6-150-00	90deg Box Connector		
440-6-160-00	Rotatable Box Connector		
440-6-170-00	Vertical Wall Base		
440-6-180-00	Rotatable Base		

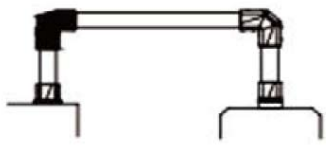
NICEVIEW

MFR #	Description		
440-6-190-00	Rotatable 90deg Corner		
440-6-200-00	15deg Beveled Connector		
440-6-000-100	44x60mm Pipe 1meter or custom	